

Standard Floor Cassette Range

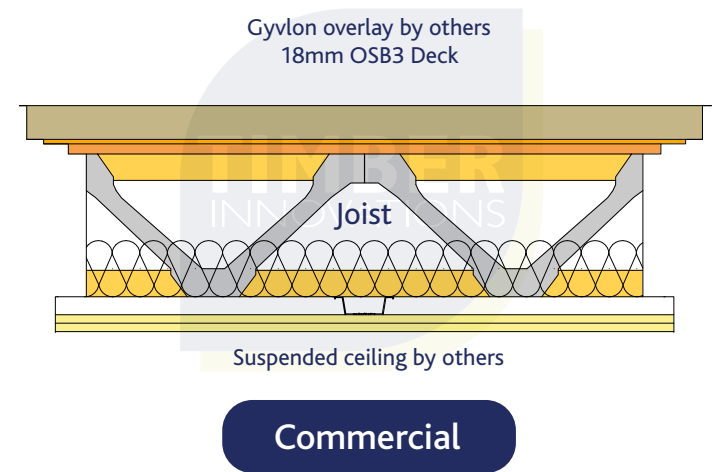

Cassettes factory produced from any of the above for these typical applications.

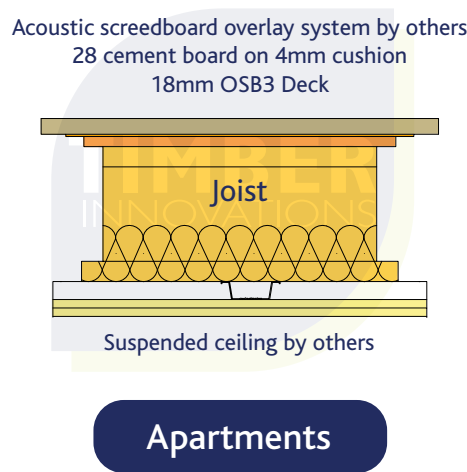
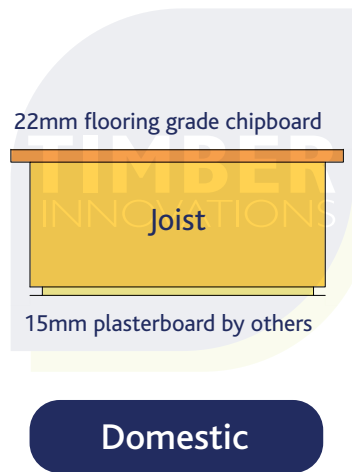

Floor Cassettes

Acoustics

Floor cassettes

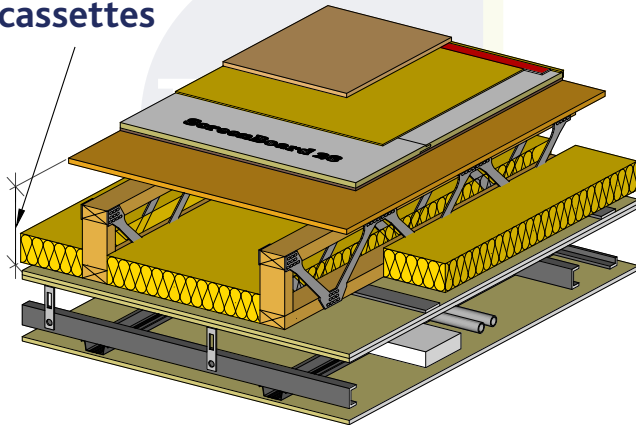

robustdetails®

- Range of separating floor solutions available
- Bespoke acoustic panel & cassette manufacture
- Lightweight acoustic screed overlay options - an alternative to concrete plank floors

Joist guidance

I-Joist Range

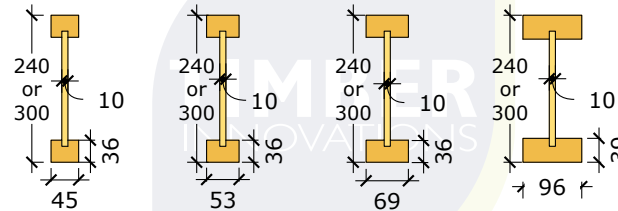

Span up to:

5.6m 5.7m 6.15m 6.7m

Some I-Joists available up to 400mm deep

Metal-web joist range

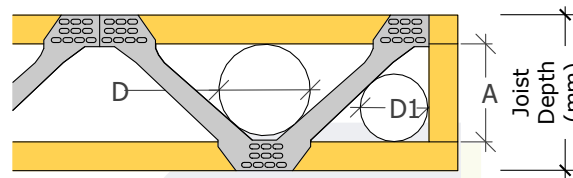

Joist Size	219	254	304	417
A (mm)	125	160	125	323
D (mm)	100	150	100	280
D1 (mm)	100	100	100	190
Span up to	6.07m	6.63m	7.38m	8.28m

Subject to load criteria

- Guidance only:
Contact our office for full joist details & capacity
- Choice of end conditions & joist spacing

Fire

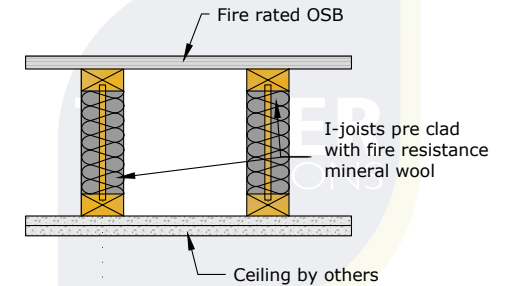

- Upgrades for I-joist fire encasement and for metal web joist components as illustrated above / below
- Fire rating specification dependent on project-specific Fire Risk assessment

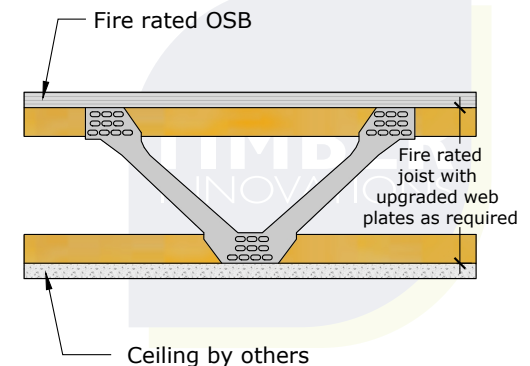

Benefits of designing-in floor cassettes

Speed of completion Increased factory-fabricated content Accuracy of floor installation Efficient installation & crane usage

Please call **0121 314 7735** for more information www.timberinnovations.co.uk